

Dali - Freestanding

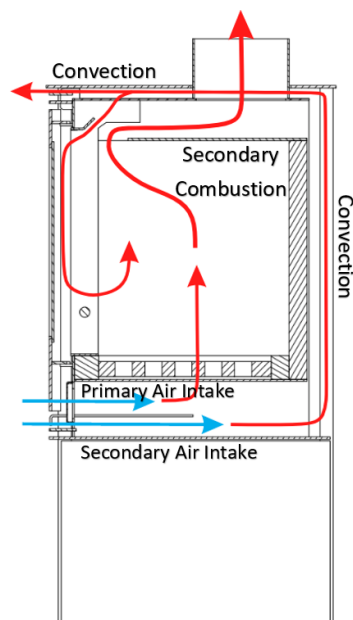

True Engineering Brilliance

Through its understated elegance and simple lines, form and function have come together brilliantly to create a unit that will complement the understated modern interiors or the more conventional surrounds. Although compact and a true space saver, this unit has an enormous heat output of up to 12kW enhanced by a well-designed convection system. The large glass window displays a mesmerizing flame pattern which is regulated through a single lever control. The air-wash system keeps the glass sooth free.

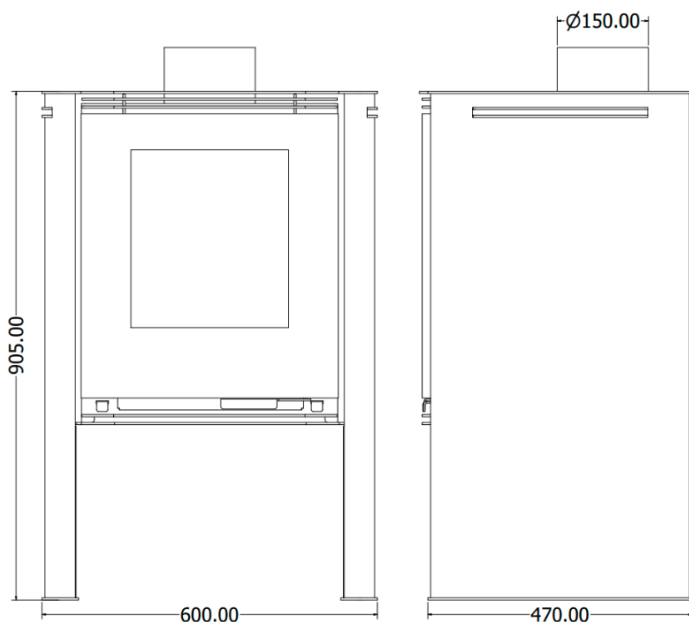

Dali - Build in







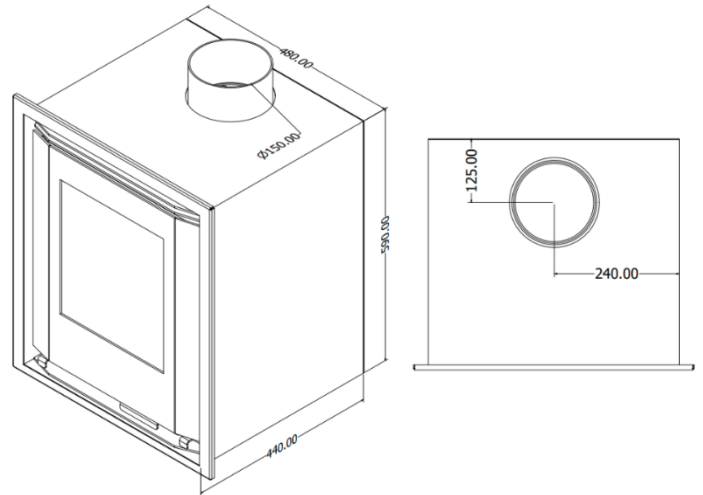

For the discerning home owner

If the perfect flame picture, freedom to compliment your decor and taste, exceptional craftsmanship and optimum heating technology are what you are after, then this unit is designed for you. Although simple in design the Dali Built-in comprises all the features of the Bogen range and has a generous heat output of up to 8kw. The simplified installation method allows building in an outer casing and fitting the unit at a later stage, making it the ideal unit when developing or doing alterations.



Dali Free Standing

Dali Built-in

	8 - 12 kW	6 - 8 kW
	60 to 100 m ²	40 to 80 m ²
	110 kg	100 kg
	905	650
	600	550
	470	450
	Ø 150 mm	Ø 150 mm

